

CSM 1608

Power Rating: 12VA⁽¹⁾⁽²⁾

PLATFORM  **PARAMETERS**

Core Size:	EF 16
Core Area:	0.205cm ²
Path Length:	3.73cm
Core Volume:	0.765cm ³
Winding Area:	0.247cm ²

Samples Available on Request

techsales@cramercoil.com
(262) 268-2150 (Inside Sales)
(262) 268-4100 (FAX)

SUGGESTED PCB LAYOUT⁽³⁾

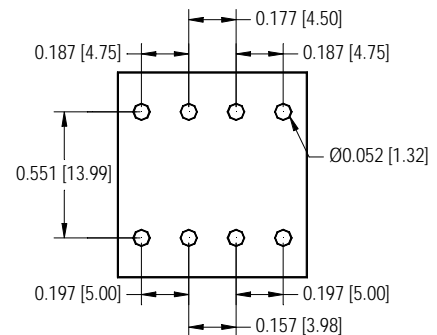

Note:
Unless otherwise specified, tolerances are
x.xxx = 0.003 [0.08]

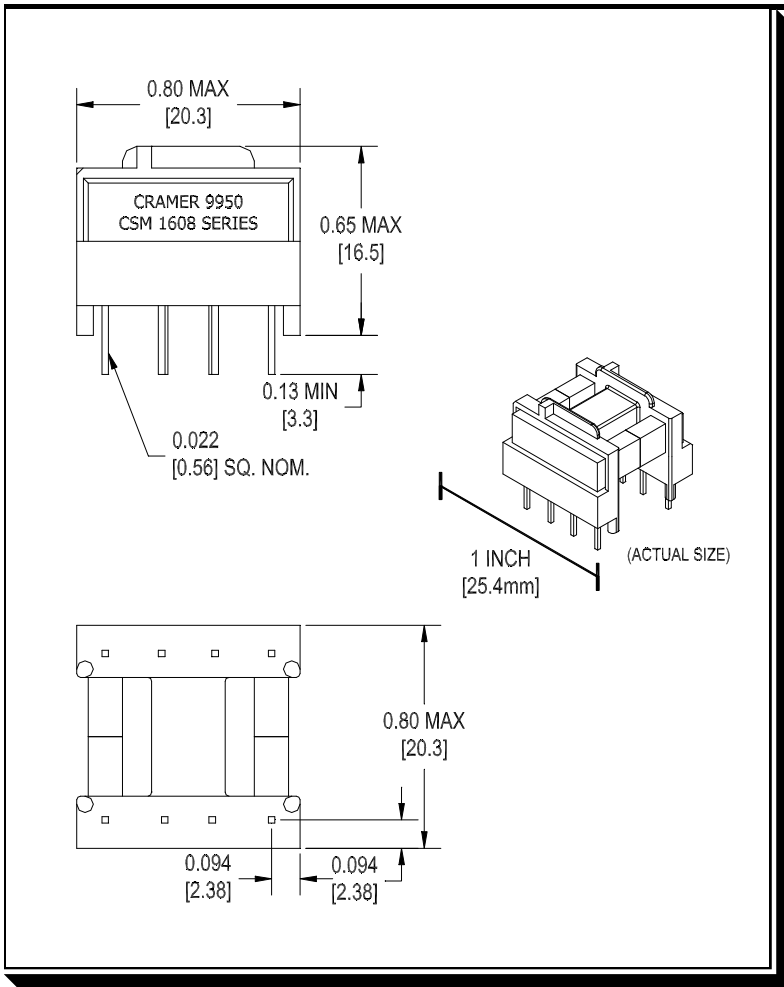

Notes:
Dimensions: inches [millimeters] (entire page)

Platform Features

- * Utilizes Economical, Efficient Construction Materials
- * UL, CSA, VDE and IEC Compatible
- * Power Rating up to 12VA⁽¹⁾⁽²⁾
- * For High Isolation Applications, Standard Platform Provides up to 2 Isolated Secondaries or 3 Common Secondaries
- * Up to 4,000 VRMS Isolation (standard configuration) between Windings
- * Lead Time 2 to 6 Weeks

(1) 12VA at 100kHz Uni-polar, 20VA at 100kHz Bi-polar.
(2) Energy Storage Limit: 225 Micro-joules (0.5 LI²).
(3) Final responsibility for the correct PCB layout resides with the user.